



Coastline Consulting & Development, LLC

Waterfront Planning, Permitting, and Development

December 8, 2009

Margaret Dein Bradley, CPG
RI Department of Environmental Management
235 Promenade Street
Providence, RI 02908

**RE: Request for Soil Disturbance Approval
434 Allens Avenue, Providence**

Dear Ms. Anderson:

As recently discussed, my firm is assisting a potential developer with waterfront permitting projects at 434 Allens Avenue in Providence. As you may recall, we are currently in the process of submitting two separate Assent applications to the Rhode Island CRMC. The CRMC application process requires that we obtain all necessary environmental approvals before they can issue the final permit.

The first application proposes the installation of a steel sheetpile bulkhead with a deadman anchor & tie-rod system. The second application will propose dredging immediately waterward of the proposed bulkhead. In conjunction with the subsequent dredging project, the proposed bulkhead will serve to facilitate acceptance of scrap metal from commercial vessels. The vessels will temporarily berth in a parallel fashion along the bulkhead. The scrap metal will then be off-loaded from the vessels and transported off-site to an appropriate upland recycling facility. The proposed bulkhead and dredging activities have been illustrated on the enclosed drawings for your review.

Per your instruction, and in accordance with the property's Environmental Land use Restriction (ELUR), we are formally requesting approval to conduct the necessary earthwork to install the bulkhead. Details of the earthwork activities are outlined in the attached project specific Soil Management Plan. To satisfy the CRMC application requirements, we would appreciate written confirmation that the proposed work meets the conditions of the ELUR and is satisfactory to the RIDEM.

Feel free to contact me if you have any questions or comments at 203/245.8138 or david@coastlineconsulting-ct.com. We appreciate your assistance and look forward to hearing from you.

Sincerely,

David R. Provencher
Coastline Consulting & Development, LLC

Enclosures:
CRMC Application Drawings
Soil Management Plan

RECEIVED
D.E.M./O.W.M.
2010 JAN -4 P 12:56

RECEIVED
D.E.M. / O.W.M.
2010 JAN -4 P 12:59

SOIL MANAGEMENT PLAN

434/444 Allens Avenue (Plat 47, Lot 601; Plat 55, Lot 10), Providence, RI

This Soil Management Plan (SMP) has been prepared to establish procedures that will be followed during the bulkhead installation at 434 & 444 Allens Avenue in Providence, Rhode Island. This proposed project requires the need to manage soils excavated from the subsurface. The plan serves to supplement, and will be initiated by, the RIDEM notification requirement established by the Environmental Land Use Restriction (ELUR) for the property.

Background

The property is located at 434 & 444 Allens Avenue in Providence. According to the U.S. EPA, Region 1 – New England, the site was formerly "...owned by various parties including U.S. Lumber Company and Putnam Lumber Company. From 1972 to 1979, the property was owned by Texaco, Inc. Refine Met International (Refine Met) acquired the property in 1979 and reportedly used the property as a resource recovery facility where scrap metal, computer parts, circuit boards, capacitors, radios, and selected electronic components were shredded. Capacitors manufactured prior to the 1970s frequently contained dielectric fluid composed of polychlorinated biphenyls (PCBs). On-site activities conducted while Refine Met occupied the property are unknown. Boliden purchased the property from Refine Met in 1983 and operated the site as a resource recovery facility engaged in the reclamation of precious metals and minerals from 1983 to 1989. Scrap metals were received in bulk form, shredded, sampled, categorized, and accumulated for shipment to smelters overseas. The property is currently inactive."

The property was found to contain PCBs during a site investigation performed at the property. More recently, the site has been remediated and been found in compliance with RIDEM's Rules and Regulations for the Investigation and Remediation of Hazardous Material Releases and has remained undeveloped since this time. The Department approved remedy apparently included the excavation of contaminated cells and filling with clean material. The regulated site soils are covered with Department approved engineered controls, consisting of clean soil and vegetation in order to prevent direct exposure to regulated soils and/or infiltration through soils which exceed the Department's Method 1 (GA or GB) Leachability Criteria.

Project Purpose

The purpose of this plan is to provide precautions and measures to be taken during and after construction to minimize soil erosion and sedimentation. The proposed activities include installation of a steel sheetpile bulkhead with a deadman anchor and tie-rod system. All components will be located landward of the mean high water line. In conjunction with a subsequent dredging project, the proposed structure will serve to facilitate acceptance of scrap metal from commercial vessels. The proposed activities involve no change in grade landward of the bulkhead location and no construction of above-ground structures. As a result, the proposed project will maintain existing upland topography.

Applicable Area

This SMP and affiliated ELUR, which restricts the property to Industrial/Commercial use, pertains to the entire property.

Project Details

The proposed activities include installation of a steel sheetpile bulkhead with a deadman anchor and tie-rod system. All components will be constructed landward of the mean high water line. The proposed activities involve no change in grade landward of the bulkhead location with no above-ground structures. As a result, the proposed project will maintain existing upland topography. The anticipated construction methodology and project sequencing is outlined in the following section. At this time, it is projected that a total of approximately 2,146 cubic yards of material will be temporarily excavated for the bulkhead tie-back system in multiple stages. The limit of this temporary excavation is shown on the application drawings. Any excess soil will be redeposited on-site per RIDEM instruction and approval. The project is anticipated to take approximately 90 working days to complete.

Construction Methodology & Project Sequencing

The installation of the new steel bulkhead and tie-back system will be conducted in multiple stages as outlined below.

1. The first phase of the project will consist of installing the steel sheeting. The bulkhead location will be properly staked with survey equipment prior to the initiation of construction activities. The installation of the sheeting will be conducted from a land based crane using a vibratory hammer. No excavation is planned with this phase, as the contractor will install the sheeting by ground penetration. The contractor will start at the northerly end of the property and work in a southerly direction, installing all sheeting in its entirety prior to installation of the deadman system.
2. Next, the contractor will begin installation of the tie-back system by excavating the soil on the landward side of the new steel sheeting. The work will be conducted from the upland, landward of the mean high water line, and will not impact coastal resources. This work will be accomplished by use of a backhoe stationed on the upland. The contractor will temporarily stockpile the backfill material on an upland portion of the site. A silt fence will be installed around the perimeter of all stockpiled material.
3. Next, the contractor will begin installing the upland concrete deadmen. Temporary timber framing will be constructed to form the concrete deadman. The deadman will be then poured by machinery stationed from the upland. Once the concrete has cured, the timber forms will be removed.
4. Next, the Contractor will begin installing the walers and tie-rods. Twelve-inch walers will be installed on the landward face of the new steel sheeting. Tie-rods will then be connected from the deadman system to the walers on the backside of

the new steel sheeting. Once the steel tie-rods are connected, geotextile fabric and crushed stone will be installed on the immediate landward side of the bulkhead. A backhoe and skid steer will return the ground to existing grade.

Soil Management

The direct exposure pathway is the primary concern at the site. Individuals engaged in activities at the site may be exposed through incidental ingestion, dermal contact, or inhalation of vapors or entrained soil particles if proper precautions are not taken. Therefore, the following procedures will be followed to minimize the potential of exposure.

1. All standards and specifications set forth in the most recent RI Soil Erosion and Sediment Control Handbook (RISESCH) will be strictly adhered to. Control measures will follow the specifications depicted in the attached R.I. Standards drawings from the Rhode Island Department of Transportation.
2. Hay bales will be toed in to a depth of 3 to 4 inches and maintained by replacing bales where necessary until permanent re-vegetation of the site is completed.
3. Where natural or manmade slopes are or have become susceptible to erosion, the slopes will be graded to a suitable slope and re-vegetated with thick rooting brush vegetation. Mulch will be applied as necessary to provide protection against erosion until the vegetation is established.
4. Construction will be timed to accommodate runoff flow and to allow flows over exposed, un-stabilized soils, or into or through the area of temporary excavation.
5. During site work, the appropriate precautions will be taken to restrict unauthorized access to the property.
6. During all site/earth work, dust suppression (i.e. watering, etc) techniques must be employed at all times. If it is anticipated due to the nature of the contaminants of concern that odors may be generated during site activities, air monitoring and means to control odors will be utilized, as appropriate (i.e. odor-suppressing foam, etc).
7. In the event that an unexpected observation or situation arises during site work, such activities will immediately stop. Workers will not attempt to handle the situation themselves but will contact the appropriate authority for further direction.
8. In the event that certain soils on site were not previously characterized, these soils are presumed to be regulated until such time that it is demonstrated to the Department, through sampling and laboratory analysis that they are not regulated. (For example, presumptive remedies or locations of previously inaccessible soil.)

9. If excess soil is generated/excavated from the property, the soil is to remain on-site for analytical testing, to be performed by an environmental professional, in order to determine the appropriate disposal and/or management options. The soil will be placed on and covered with polyethylene/plastic sheeting during the entire duration of its staging and secured with appropriate controls to limit the loss of the cover and protect against storm-water and / or wind erosion (i.e. hay bales, silt fencing, rocks, etc).
10. Excavated soils will be staged and temporarily stored in a designated area of the property. Within reason, the storage location will be selected to limit the unauthorized access to the materials (i.e., away from public roadways/walkways).
11. In the event that stockpiled soils pose a risk or threat of leaching hazardous materials, a proper leak-proof container (i.e. drum or lined roll-off) or secondary containment will be utilized.
12. Soils excavated from the site will not be re-used as fill on residential property. Temporarily excavated fill material will be backfilled or redeposited on-site following completion of earthwork activities.
13. Although it is not anticipated at this time, site soils that are to be disposed of off-site will be done so at a licensed facility in accordance with all local, state, and federal laws. Copies of the material shipping records associated with the disposal of the material will be maintained by the site owner and included in the annual inspection report for the site.
14. Best soil management practices will be employed at all times and regulated soils will be segregated into separate piles (or cells or containers) as appropriate based upon the results of any necessary analytical testing for reuse on-site.
15. All non-disposable equipment used during the soil disturbance activities will be properly decontaminated as appropriate prior to removal from the site. All disposable equipment used during the soil disturbance activities will be properly containerized and disposed of following completion of the work. All vehicles utilized during the work shall be properly decontaminated as appropriate prior to leaving the site.
16. At the completion of site work, all exposed soils will be recapped with Department approved engineered controls (2 ft of clean fill or 1 foot of clean fill underlain with a geotextile liner) consistent or better than the site surface conditions prior to the work that took place. These measures will be consistent with the Department approved ELUR recorded on the land records. The clean fill material brought on site will meet the Department's Method 1 Residential Direct Exposure Criteria or be designated by an Environmental Professional as Non-Jurisdictional under the Remediation Regulations. The Annual Inspection Report for the site, or Closure Report if applicable, will either include analytical sampling results from the fill demonstrating compliance or alternatively include written certification by an Environmental Professional that the fill is not jurisdictional.

Groundwater Management

In accordance with the ELUR, groundwater under the property will not be used for potable purposes. The temporary excavation necessary to install the bulkhead tie-back system is estimated to reach an approximate depth of 5' below grade and should not affect groundwater. However, any unanticipated pumping of groundwater, which may be necessary for de-watering, will be discharged into sediment traps consisting of a minimum of staked hay bale rings enclosing crushed stone or trap rock of a size sufficient to disperse inflow velocity. Hay bales encircling these traps will be recessed 4 to 6 inches into the soil and maintained.

Worker Health and Safety

To ensure the health and safety of on-site workers, persons involved in the excavation and handling of the material on site will wear a minimum of Level D personal protection equipment, including gloves, work boots and eye protection. Workers will also be required to wash their hands with soap and water prior to eating, drinking, smoking, or leaving the site.

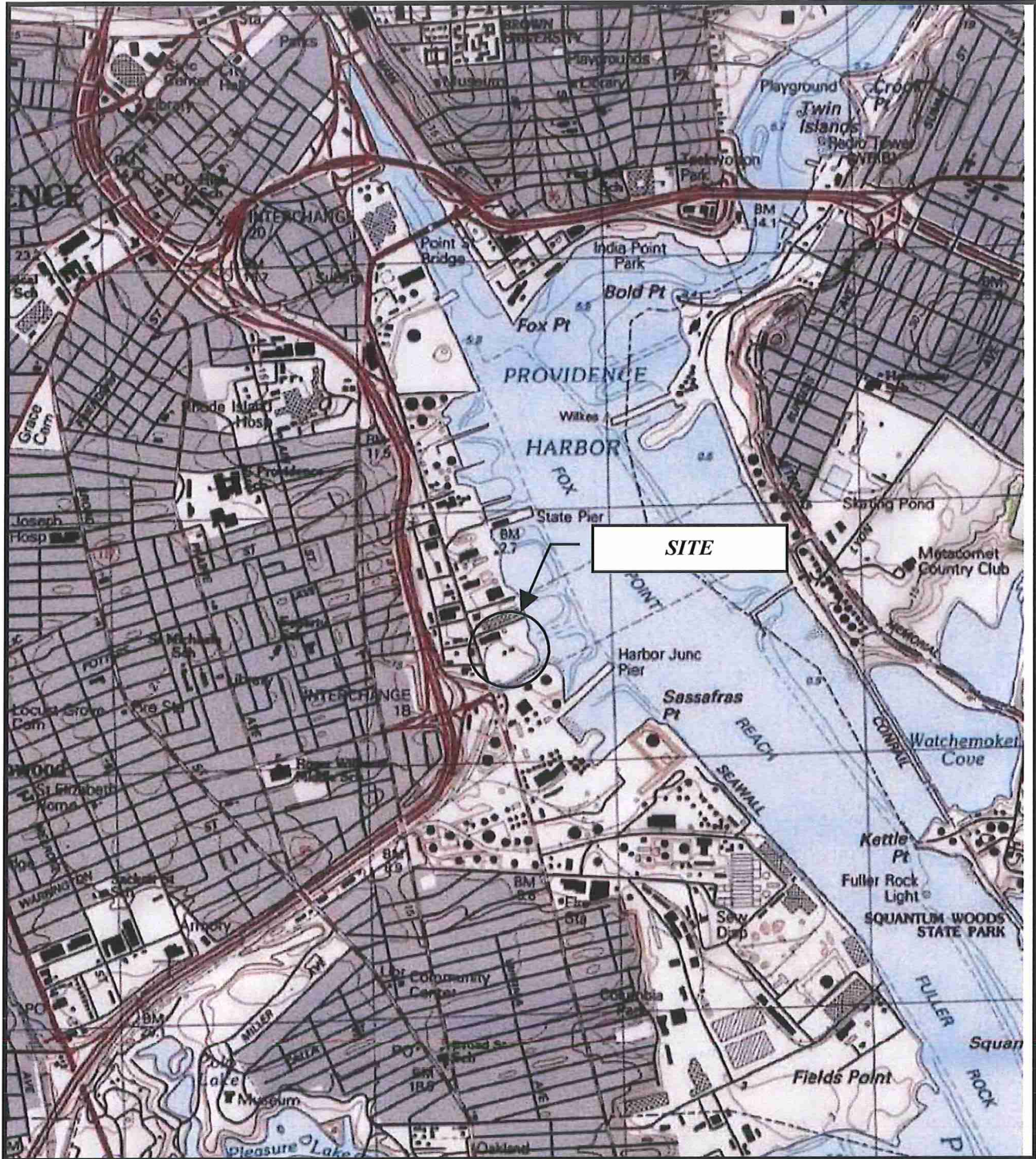

RECEIVED
D.E.M. / O.W.M.
2010 JAN -4 P 12:5

Coastline Consulting & Development
5-B Old Post Road, Madison CT 06443
(203) 245-8138

FIGURE 1 OF 10
SITE LOCATION MAP

ACR REALTY, LLC
RHODE ISLAND RECYCLED METALS
434 & 444 ALLENS AVE
PROVIDENCE, RHODE ISLAND

DECEMBER 8, 2009

SCALE: 1 = 12,000

NOTE: MAP TAKEN FROM 7.5 MINUTE USGS TOPOGRAPHIC MAPS OF THE PROVIDENCE, RHODE ISLAND QUADRANGLE, 1960 (PHOTOINSPECTED 1976, PHOTOREVISED 1984).

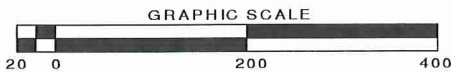
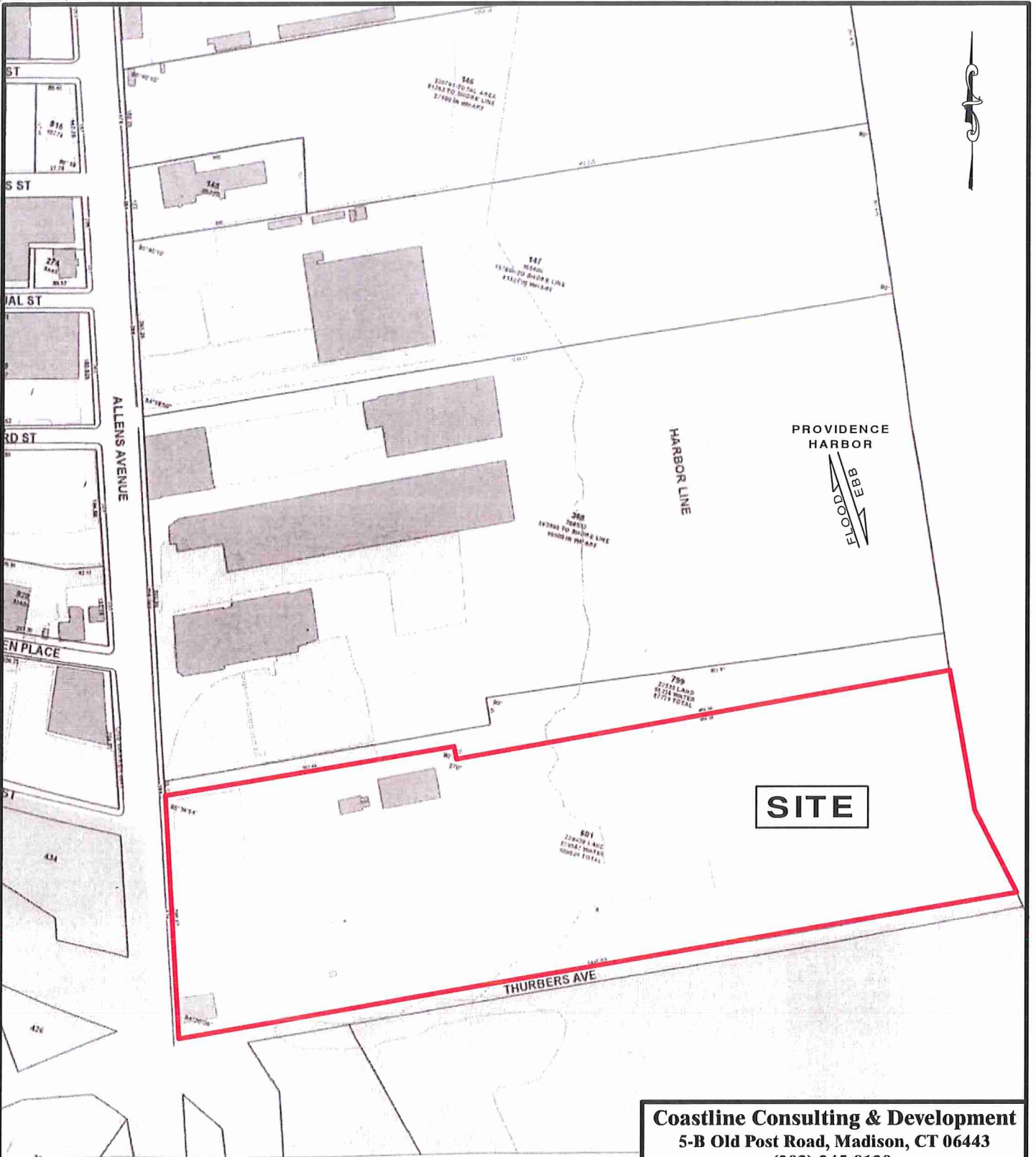

Coastline Consulting & Development
 5-B Old Post Road, Madison, CT 06443
 (203) 245-8138

FIGURE 2 OF 10
 SITE PLAN VIEW

ACR REALTY, LLC
 RHODE ISLAND RECYCLED METALS
 434 & 444 ALLENS AVENUE
 PROVIDENCE, RHODE ISLAND

DECEMBER 8, 2009

SCALE: 1" = 200'

NOTES:
 1. THIS MAP IS FOR PLANNING AND PERMITTING PURPOSES ONLY AND IS NOT INTENDED FOR BID DOCUMENTS OR CONSTRUCTION.
 2. REFERENCE IS MADE TO CITY OF PROVIDENCE ASSESSOR PLAT #47.

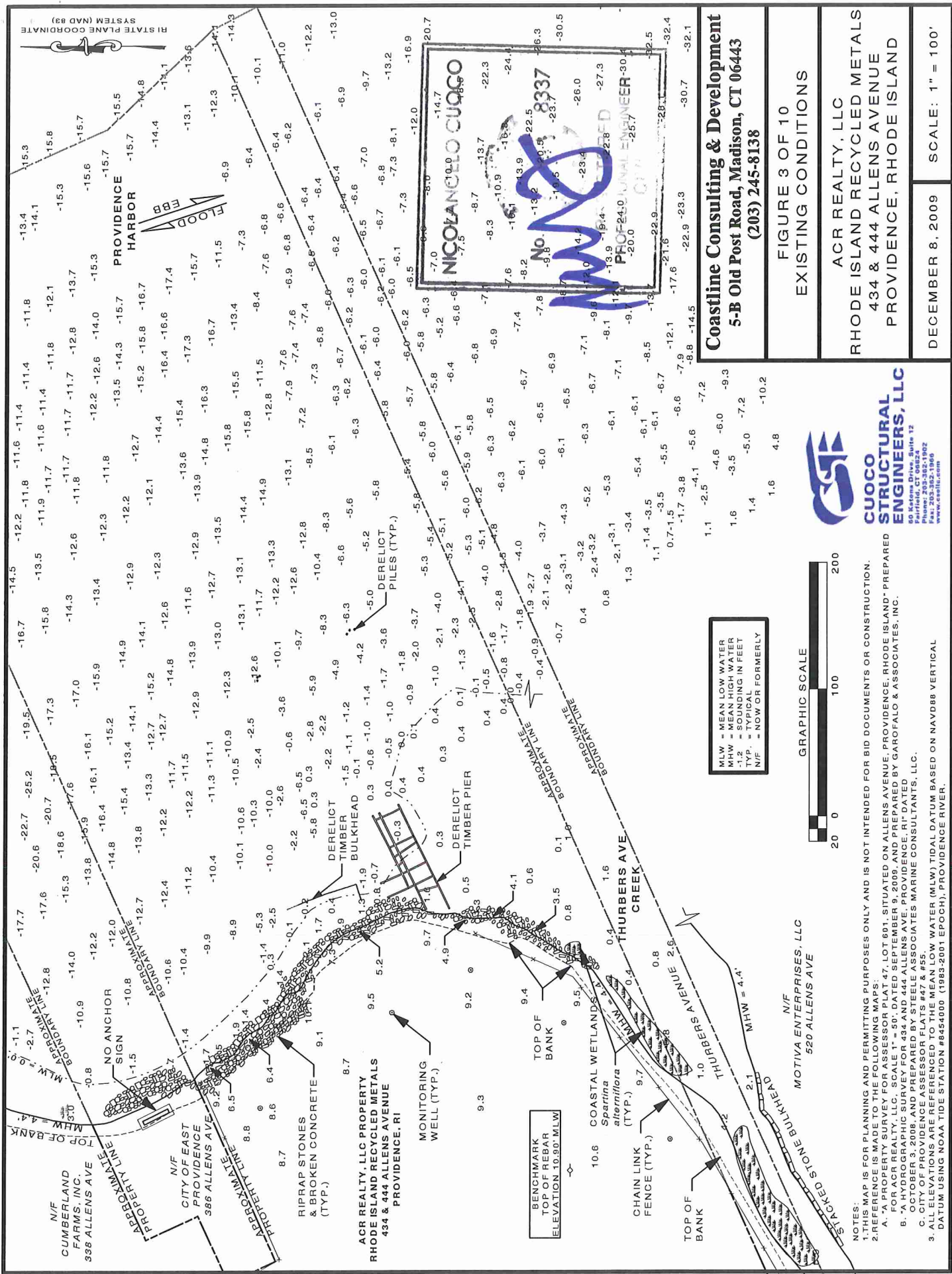

Coastline Consulting & Development
 5-B Old Post Road, Madison, CT 06443
 (203) 245-8138

FIGURE 3 OF 10
 EXISTING CONDITIONS

ACR REALTY, LLC
 RHODE ISLAND RECYCLED METALS
 434 & 444 ALLENS AVENUE
 PROVIDENCE, RHODE ISLAND

DECEMBER 8, 2009 SCALE: 1" = 100'



CUOCO STRUCTURAL ENGINEERS, LLC
 100 State Street, Suite 112
 Pawtucket, CT 06257
 Phone: 203-382-1902
 Fax: 203-382-1900
 www.cuoco.com

MLW = MEAN LOW WATER
 1-2 = SOUNDING IN FEET
 TYP. = TYPICAL
 N/F = NOW OR FORMERLY

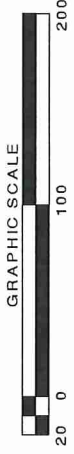

- NOTES:
- THIS MAP IS FOR PLANNING AND PERMITTING PURPOSES ONLY AND IS NOT INTENDED FOR BID DOCUMENTS OR CONSTRUCTION.
 - REFERENCE IS MADE TO THE FOLLOWING MAPS:
 - A PROPERTY SURVEY FOR ASSESSOR PLAT 47, LOT 601, SITUATED ON ALLENS AVENUE, PROVIDENCE, RHODE ISLAND, PREPARED FOR ACR REALTY, LLC, SCALE 1" = 50', DATED SEPTEMBER 9, 2009, AND PREPARED BY GAROFALO & ASSOCIATES, INC.
 - A HYDROGRAPHIC SURVEY FOR 434 AND 444 ALLENS AVE, PROVIDENCE, RI, DATED OCTOBER 3, 2008, AND PREPARED BY STEELE ASSOCIATES MARINE CONSULTANTS, LLC.
 - PROVIDENCE PLATS #42 & #50.
 - ALL ELEVATIONS ARE MEAN LOW WATER (MLW) TIDAL DATUM, BASED ON NAVD88 VERTICAL DATUM USING NOAA TIDE STATION #8454000 (1983-2001 EPOCH), PROVIDENCE RIVER.

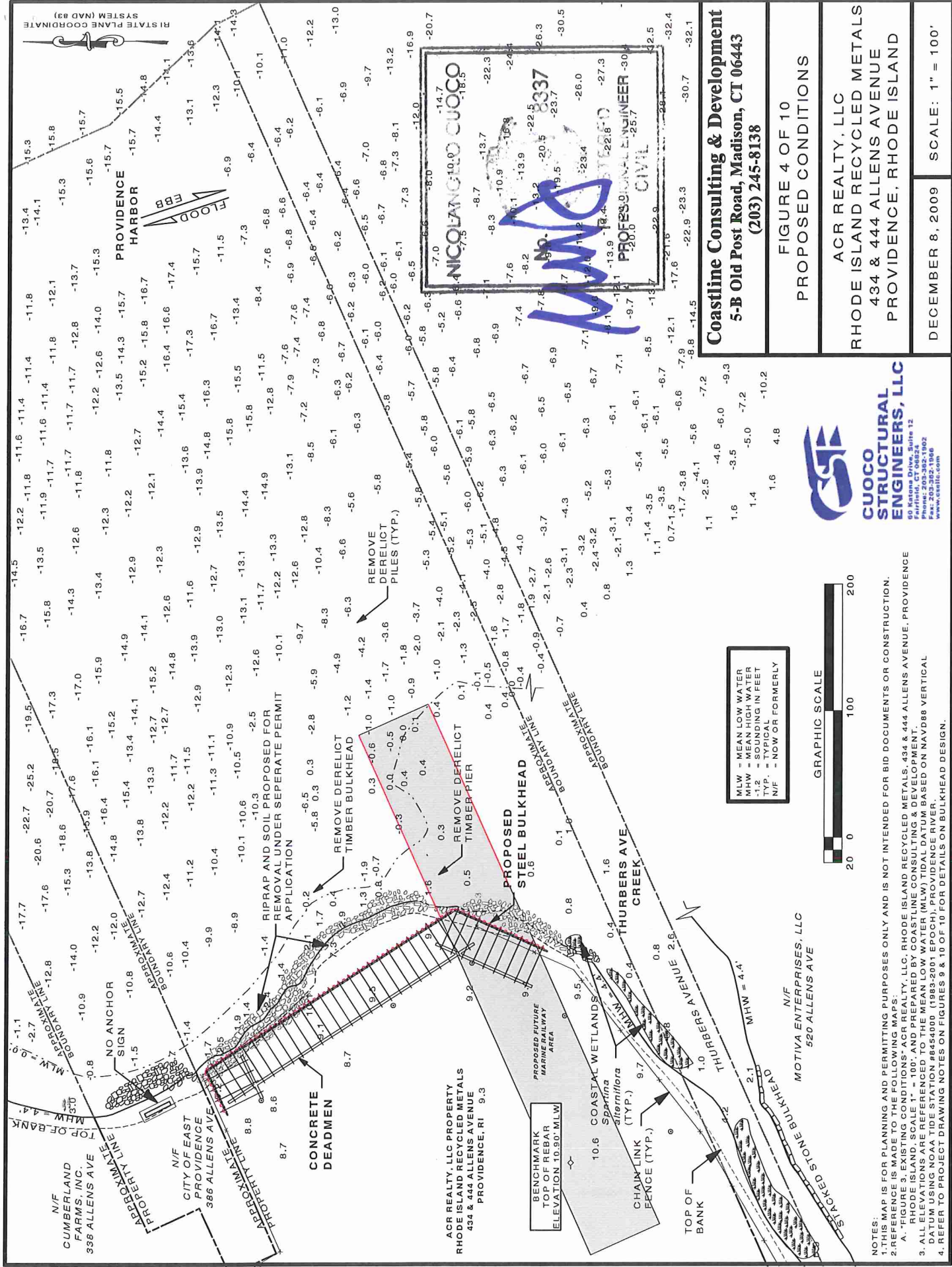

Coastline Consulting & Development
 5-B Old Post Road, Madison, CT 06443
 (203) 245-8138

FIGURE 4 OF 10
 PROPOSED CONDITIONS

ACR REALTY, LLC
 RHODE ISLAND RECYCLED METALS
 434 & 444 ALLENS AVENUE
 PROVIDENCE, RHODE ISLAND

DECEMBER 8, 2009 SCALE: 1" = 100'

CUOCO STRUCTURAL ENGINEERS, LLC
 90 Skansie Drive, Suite 12
 Fairfield, CT 06424
 Phone: 203-382-1802
 Fax: 203-382-1803
 www.cuocofirm.com

MLW = MEAN LOW WATER
 MHW = MEAN HIGH WATER
 -1.2 = SOUNDING IN FEET
 TYP. = TYPICAL
 N/F = NOW OR FORMERLY

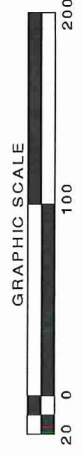

- NOTES:
- THIS MAP IS FOR PLANNING AND PERMITTING PURPOSES ONLY AND IS NOT INTENDED FOR BID DOCUMENTS OR CONSTRUCTION.
 - REFERENCE IS MADE TO THE FOLLOWING MAPS:
 - A. FIGURE 3, EXISTING CONDITIONS, ACR REALTY, LLC, RHODE ISLAND RECYCLED METALS, 434 & 444 ALLENS AVENUE, PROVIDENCE, RHODE ISLAND, SCALE 1" = 100', AND PREPARED BY COASTLINE CONSULTING & DEVELOPMENT.
 - B. FIGURE 1, EXISTING CONDITIONS, ACR REALTY, LLC, RHODE ISLAND RECYCLED METALS, 434 & 444 ALLENS AVENUE, PROVIDENCE, RHODE ISLAND, SCALE 1" = 100', AND PREPARED BY COASTLINE CONSULTING & DEVELOPMENT.
 - ALL ELEVATIONS ARE REFERENCED TO THE MEAN LOW WATER (MLW) TIDAL DATUM BASED ON NAVD88 VERTICAL DATUM. THE MEAN HIGH WATER (MHW) TIDAL DATUM IS 4.4' ABOVE THE MEAN LOW WATER (MLW) TIDAL DATUM.
 - REFER TO PROJECT DRAWING NOTES ON FIGURES 9 & 10 OF 10 FOR DETAILS ON BULKHEAD DESIGN.

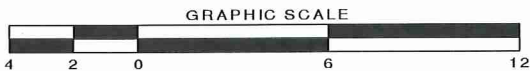
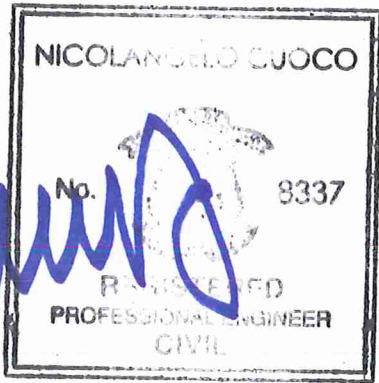
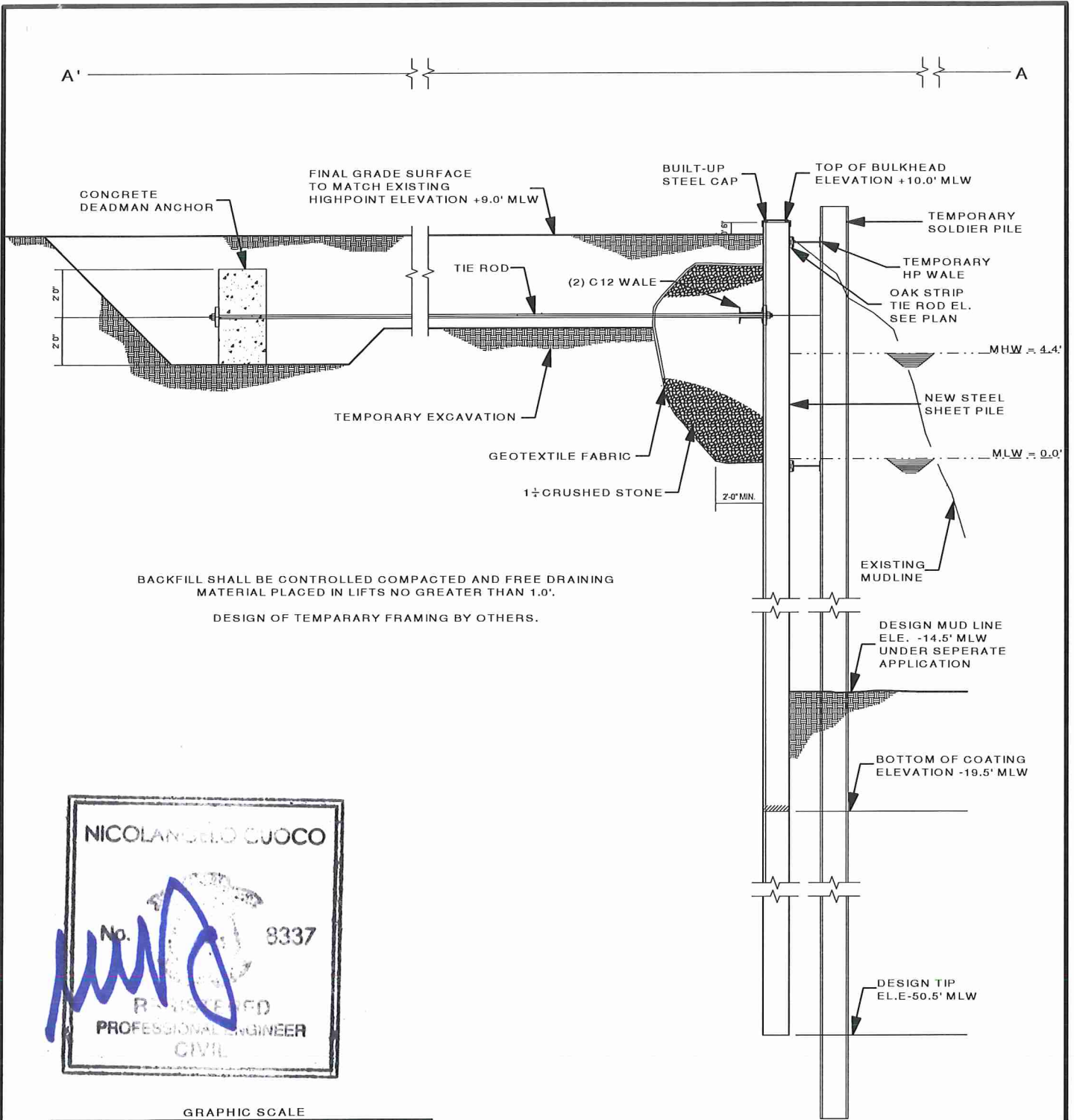

NOTES:

- THIS MAP IS FOR PLANNING AND PERMITTING PURPOSES ONLY AND IS NOT INTENDED FOR BID DOCUMENTS OR CONSTRUCTION.
- REFERENCE IS MADE TO THE FOLLOWING MAPS:
A. "FIGURE 5, PROPOSED CONDITIONS" ACR REALTY, LLC, RHODE ISLAND RECYCLED METALS, 434 & 444 ALLENS AVENUE, PROVIDENCE RHODE ISLAND, SCALE 1" = 40', AND PREPARED BY COASTLINE CONSULTING & DEVELOPMENT AND CUOCO STRUCTURAL ENGINEERING, LLC.
- ALL ELEVATIONS ARE REFERENCED TO THE MEAN LOW WATER (MLW) TIDAL DATUM BASED ON NAVD88 VERTICAL DATUM USING NOAA TIDE STATION #8454000 (1983-2001 EPOCH), PROVIDENCE RIVER.
- REFER TO PROJECT DRAWING NOTES ON FIGURES 9 & 10 OF 10 FOR DETAILS ON BULKHEAD DESIGN.



Coastline Consulting & Development
5-B Old Post Road, Madison, CT 06443
(203) 245-8138

FIGURE 6 OF 10
CROSS SECTION DETAIL 1

ACR REALTY, LLC
RHODE ISLAND RECYCLED METALS
434 & 444 ALLENS AVENUE
PROVIDENCE, RHODE ISLAND

DECEMBER 8, 2009

SCALE: 1" = 6'

WALE CONNECTION DETAIL

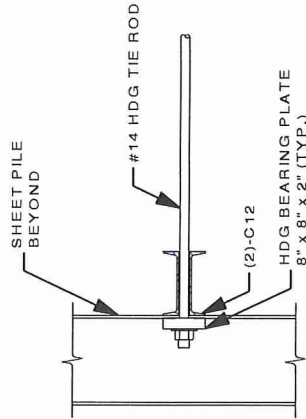
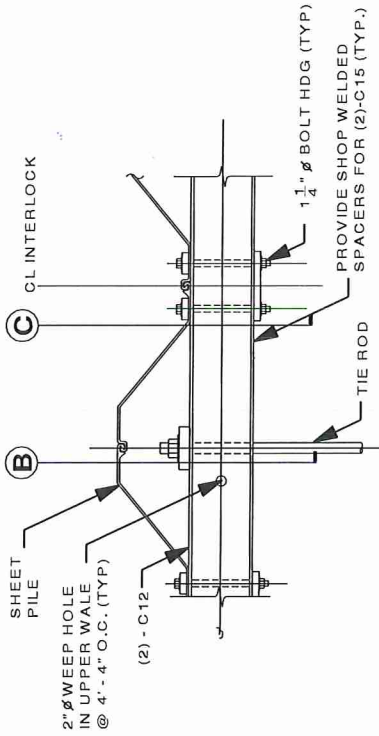

SECTION B

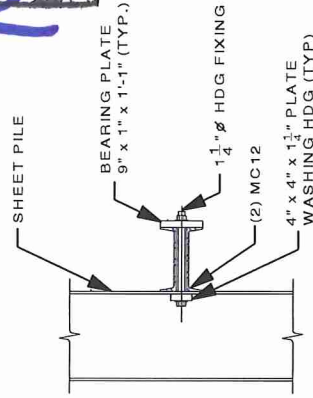

SECTION C

1. HOLES FOR SHEET PILE SHALL BE FIELD DRILLED
2. COAT DRILLED SURFACE PRIOR TO BOLT INSTALLATION

- NOTES:
1. THIS MAP IS FOR PLANNING AND PERMITTING PURPOSES ONLY AND IS NOT INTENDED FOR BID DOCUMENTS OR CONSTRUCTION.
 2. REFERENCE IS MADE TO THE FOLLOWING MAPS:
 - A. "FIGURE 4, PROPOSED CONDITIONS" ACR REALTY, LLC, RHODE ISLAND RECYCLED METALS, 434 & 444 ALLENS AVENUE, PROVIDENCE RHODE ISLAND, SCALE 1" = 100', AND PREPARED BY COASTLINE CONSULTING & DEVELOPMENT AND CUOCO STRUCTURAL ENGINEERING, LLC.
 3. ALL ELEVATIONS ARE REFERENCED TO THE MEAN LOW WATER (MLW) TIDAL DATUM BASED ON NAVD88 VERTICAL DATUM USING NOAA TIDE STATION #8454000 (1983-2001 EPOCH), PROVIDENCE RIVER.
 4. REFER TO PROJECT DRAWING NOTES ON FIGURES 9 & 10 OF 10 FOR DETAILS ON BULKHEAD DESIGN.

WALE SPLICE DETAIL

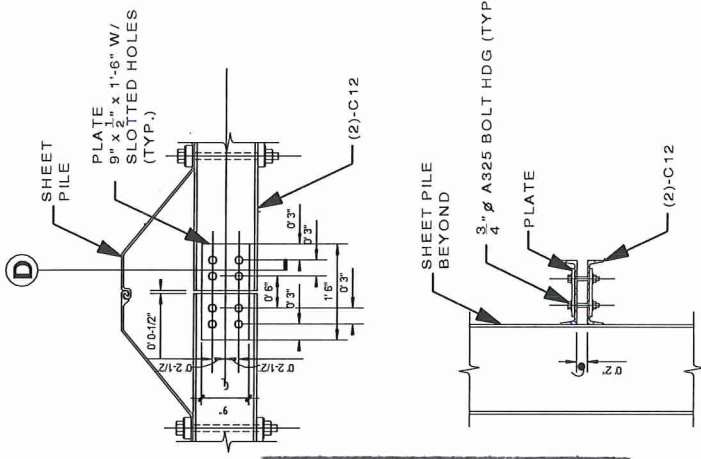

SECTION D

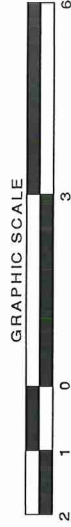

Coastline Consulting & Development
 5-B Old Post Road, Madison, CT 06443
 (203) 245-8138

FIGURE 7 OF 10
 CROSS SECTION DETAIL 2

ACR REALTY, LLC
 RHODE ISLAND RECYCLED METALS
 434 & 444 ALLENS AVENUE
 PROVIDENCE, RHODE ISLAND

DECEMBER 8, 2009
 SCALE: 1" = 3'

CUOCO STRUCTURAL ENGINEERS, LLC
 80 Katona Drive, Suite 12
 Pawtucket, RI 02862
 Phone: 401-739-8902
 Fax: 401-739-1906
 www.cseilc.com

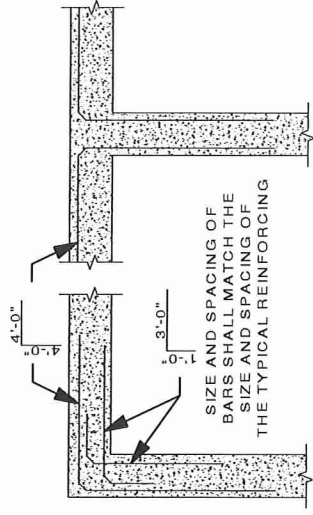
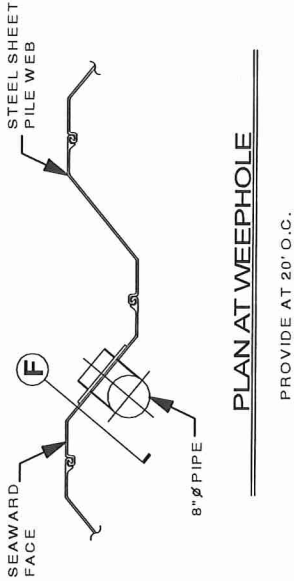
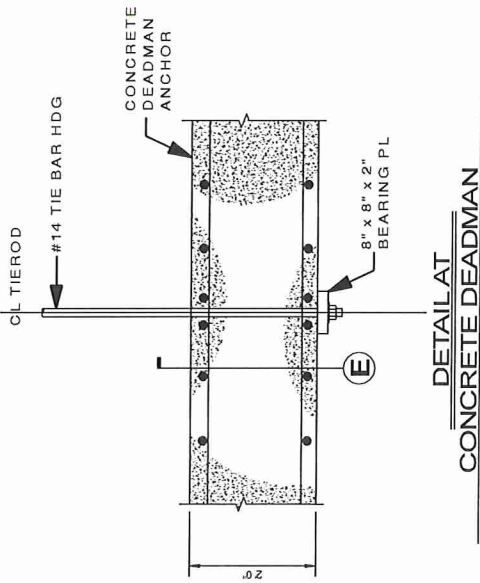

CONCRETE REINFORCING DETAIL

SEE CONCRETE DEADMAN DETAILS FOR TYPICAL REINFORCING SIZE AND SPACING

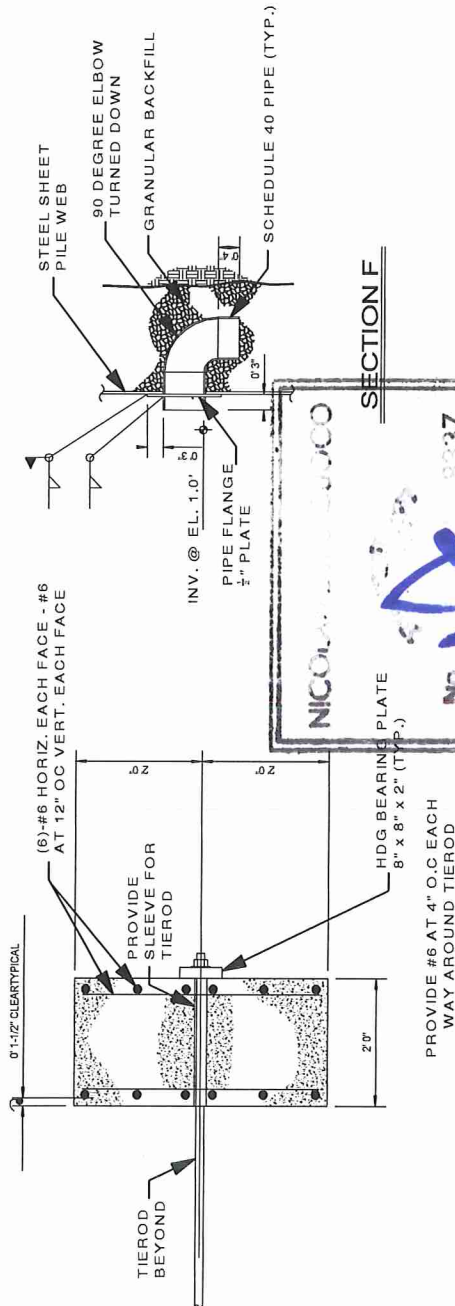

SECTION E

PROVIDE #6 AT 4\"/>

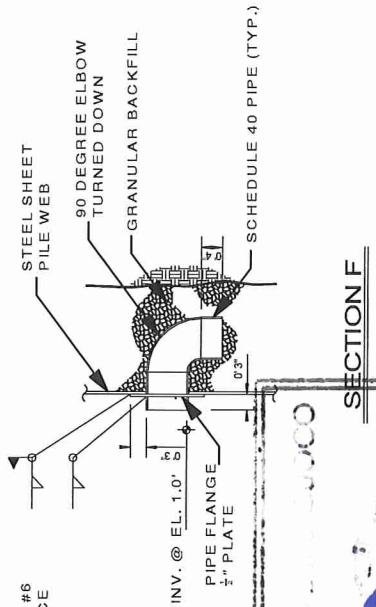

SECTION F

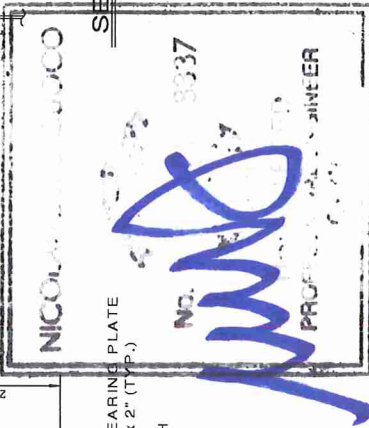

- NOTES:
1. THIS MAP IS FOR PLANNING AND PERMITTING PURPOSES ONLY AND IS NOT INTENDED FOR BID DOCUMENTS OR CONSTRUCTION.
 2. REFERENCE IS MADE TO THE FOLLOWING MAPS:
 - A. "FIGURE 4. PROPOSED CONDITIONS" ACR REALTY, LLC, RHODE ISLAND RECYCLED METALS, 434 & 444 ALLENS AVENUE, PROVIDENCE RHODE ISLAND, SCALE 1" = 100', AND PREPARED BY COASTLINE CONSULTING & DEVELOPMENT AND CUOCO STRUCTURAL ENGINEERING, LLC.
 3. ALL ELEVATIONS ARE REFERENCED TO THE MEAN LOW WATER (MLW) TIDAL DATUM BASED ON NAVD88 VERTICAL DATUM USING NOAA TIDE STATION #8454000 (1993-2001 EPOCH), PROVIDENCE RIVER.
 4. REFER TO PROJECT DRAWING NOTES ON FIGURES 9 & 10 OF 10 FOR DETAILS ON BULKHEAD DESIGN.



CUOCO STRUCTURAL ENGINEERS, LLC
 80 Watson Drive, Suite 12
 Fairfield, CT 06424
 Phone: 203-362-1902
 Fax: 203-362-1966
 www.cseinc.com



Coastline Consulting & Development
 5-B Old Post Road, Madison, CT 06443
 (203) 245-8138

FIGURE 8 OF 10
 CROSS SECTION DETAIL 3

ACR REALTY, LLC
 RHODE ISLAND RECYCLED METALS
 434 & 444 ALLENS AVENUE
 PROVIDENCE, RHODE ISLAND

DECEMBER 8, 2009
 SCALE: 1" = 3'

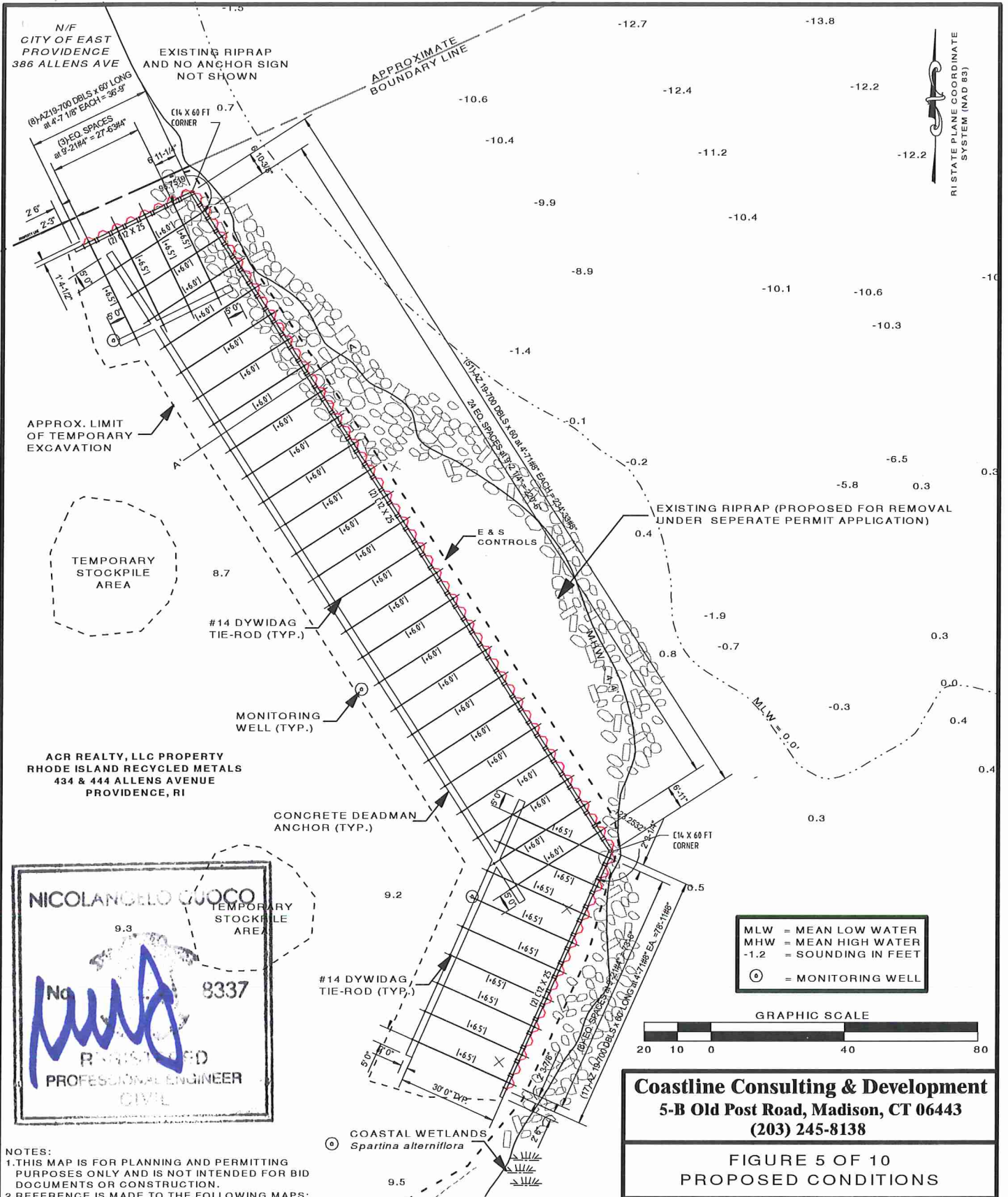

ACR REALTY, LLC PROPERTY
RHODE ISLAND RECYCLED METALS
434 & 444 ALLENS AVENUE
PROVIDENCE, RI

NICOLANGELO CUOCO

No. **8337**

[Signature]

REGISTERED
PROFESSIONAL ENGINEER
CIVIL

- NOTES:**
1. THIS MAP IS FOR PLANNING AND PERMITTING PURPOSES ONLY AND IS NOT INTENDED FOR BID DOCUMENTS OR CONSTRUCTION.
 2. REFERENCE IS MADE TO THE FOLLOWING MAPS: A. "FIGURE 4, PROPOSED CONDITIONS" ACR REALTY, LLC, RHODE ISLAND RECYCLED METALS, 434 & 444 ALLENS AVENUE, PROVIDENCE RHODE ISLAND, SCALE 1" = 100', AND PREPARED BY COASTLINE CONSULTING & DEVELOPMENT AND CUOCO STRUCTURAL ENGINEERING, LLC.
 3. ALL ELEVATIONS ARE REFERENCED TO THE MEAN LOW WATER (MLW) TIDAL DATUM BASED ON NAVD88 VERTICAL DATUM USING NOAA TIDE STATION #8454000 (1983-2001 EPOCH), PROVIDENCE RIVER.
 4. REFER TO PROJECT DRAWING NOTES ON FIGURES 9 & 10 OF 10 FOR DETAILS ON BULKHEAD DESIGN.



**CUOCO
STRUCTURAL
ENGINEERS, LLC**

60 Hatona Drive, Suite 12
Fairfield, CT 06424
Phone: 203-262-1902
Fax: 203-262-1966
www.cuoco.com

Coastline Consulting & Development
5-B Old Post Road, Madison, CT 06443
(203) 245-8138

FIGURE 5 OF 10
PROPOSED CONDITIONS

ACR REALTY, LLC
RHODE ISLAND RECYCLED METALS
434 & 444 ALLENS AVENUE
PROVIDENCE, RHODE ISLAND

DECEMBER 8, 2009

SCALE: 1" = 40'

ENGINEERING DETAIL NOTES

GENERAL NOTES:

1. THE COMPLETED STRUCTURE HAS BEEN DESIGNED TO WITHSTAND THE FOLLOWING DESIGN LIVE LOADS APPLIED IN CONJUNCTION WITH DESIGN DREDGE/MUDLINE ELEVATIONS INDICATED ON THE CONTRACT DRAWINGS.
2. ALL WORK SHALL BE IN ACCORDANCE WITH THE RHODE ISLAND STATE BUILDING CODE, NINTH EDITION WITH AN EFFECTIVE DATE OF AUGUST 1, 2007.
3. LIVE LOADS: 250 PSF UNIFORM LOAD
 8,000 LB CONCENTRATED LOAD
4. SITE INFORMATION TAKEN FROM "PROPERTY SURVEY FOR ASSESSOR PLAT 47, LOT 601" PREPARED BY GAROFALO & ASSOCIATES, INC. DATED SEPTEMBER 9, 2009.
5. SUBSURFACE SOIL INFORMATION TAKEN FROM SOIL TEST BORING LOGS PREPARED BY NEW ENGLAND BORING CONTRACTORS OF CT, INC., GLASTONBURY, CT.
6. ELEVATIONS REFERENCE LOCAL MEAN LOW WATER, UNLESS NOTED OTHERWISE.
7. THE PARCEL IS LOCATED IN FEMA FLOOD ZONES VE (EL 18) AND AE (EL 15) BASED ON FLOOD INSURANCE RATE MAP FOR THE CITY OF PROVIDENCE, RHODE ISLAND, PROVIDENCE COUNTY, COMMUNITY PANEL NUMBER 445406-0317 G, MAP NUMBER 44007C0317G WITH AN EFFECTIVE DATE OF MARCH 2, 2009.
8. ALL DETAILS SHALL BE CONSIDERED TYPICAL AND SHALL APPLY AT SAME AND SIMILAR CONDITIONS.
9. PILES SHALL BE DRIVEN STRAIGHT AND TRUE AT INDICATED LOCATIONS, WITH DEVIATION FROM THE LONGITUDINAL AXIS OF NOT MORE THAN 1/4 INCH PER FOOT. LOCATE THE PILES WITHIN 3 INCHES OF THE POSITIONS INDICATED ON THE DRAWINGS.
10. TO DETERMINE ACCURATE DIMENSIONS, DO NOT SCALE DRAWINGS. DIMENSIONS SHALL BE READ OR CALCULATED.
11. THE CONTRACTOR SHALL VERIFY THE LOCATION OF ALL UNDERGROUND UTILITY LINES, SEWERS, AND FUEL STORAGE TANKS TO AVOID ANY DAMAGE TO THESE. CONTRACTOR SHALL CONTACT "CALL BEFORE YOU DIG" PRIOR TO ANY EXCAVATION.

SELECTIVE DEMOLITION AND DISPOSAL:

1. SELECTIVE DEMOLITION AND DISPOSAL SHALL BE PERFORMED IN ACCORDANCE WITH FEDERAL, STATE, AND LOCAL PERMIT AND BUILDING CODE REQUIREMENTS.
2. THE CONTRACTOR SHALL REMOVE AND DISPOSE THOSE STRUCTURES AND DERELICT COMPONENTS REQUIRED TO PERFORM THE WORK. THIS WORK INCLUDES BUT IS NOT LIMITED TO THE EXISTING BULKHEAD, PIER, AND PILES.
3. SELECTIVE DEMOLITION INCLUDES BUT IS NOT LIMITED TO REMOVAL OF EXISTING MATERIALS, UTILITIES, AND OTHER COMPONENTS ESSENTIAL FOR A COMPLETE PROJECT.
4. THE CONTRACTOR SHALL TAKE REASONABLE CARE IN REMOVING ELEMENTS SELECTED TO BE DEMOLISHED.
5. PRIOR TO COMMENCEMENT OF DEMOLITION, THE CONTRACTOR SHALL CLEARLY MARK THE LIMITS OF THE DEMOLITION.
6. COMPLETELY REMOVE ITEMS DESIGNATED LEAVING SURFACES CLEAN, SOUND, AND READY TO RECEIVE NEW MATERIALS.
7. THE CONTRACTOR SHALL BE SOLELY RESPONSIBLE FOR THE STABILITY OF THE STRUCTURE DURING THE COURSE OF DEMOLITION.

EROSION AND SEDIMENTATION CONTROLS:

1. EROSION AND SEDIMENTATION CONTROLS SHALL BE INSTALLED AND MAINTAINED AS PER REGULATORY AUTHORIZATIONS.
2. DURING EXECUTION OF THE WORK, THE CONTRACTOR IS REQUIRED TO INSTALL AND MAINTAIN REQUIRED SEDIMENTATION AND EROSION CONTROL MEASURES TO PROTECT ADJACENT WATERWAYS, STREETS, AND PROPERTIES. MEASURES INCLUDE BUT ARE NOT LIMITED TO TEMPORARY BERMS, HAY BALES, SILT FENCES, CONTAINMENT BOOMS, AND TURBIDITY CURTAINS.
3. EROSION AND SEDIMENTATION CONTROL DEVICES AND PROVISIONS SHALL BE MAINTAINED IN OPERATIONAL CONDITION BY THE CONTRACTOR AND SHALL BE REMOVED AND LEGALLY DISPOSED AT THE COMPLETION OF THE PROJECT.

PILE DRIVING:

1. DRIVE THE PILES STRAIGHT AND TRUE AT INDICATED LOCATIONS, WITH DEVIATION FROM THE LONGITUDINAL AXIS OF NOT MORE THAN 1/4 INCH PER FOOT.
2. LOCATE THE PILES WITHIN 3 INCHES OF THE POSITIONS INDICATED ON THE DRAWINGS.
3. CONTINUOUSLY DRIVE EACH PILE TO REACH THE CAPACITY AND/OR FULL EMBEDDED LENGTH CALLED FOR ON THE DRAWINGS.
4. WITHDRAW PILES THAT ENCOUNTER UNDERGROUND OBSTRUCTIONS SUFFICIENT TO IMPEDE PILE DRIVING. REDRIVE AS CLOSE AS POSSIBLE TO ORIGINAL POSITION, SUBJECT TO REVIEW OF THE OWNER. REMOVE PILES WHICH SPLIT, BROOM, BREAK OR DRIVE OUT OF LINE. DRIVE ANOTHER PILE IN ITS PLACE. PROVIDE AND MAINTAIN NECESSARY LIGHTING AND BARRIERS TO ADEQUATELY ASSURE PUBLIC SAFETY. PROVIDE ADEQUATE SAFEGUARDS TO PROTECT FROM DAMAGE IMPROVEMENTS ON THE WORK SITE AND ON ADJACENT PROPERTIES.

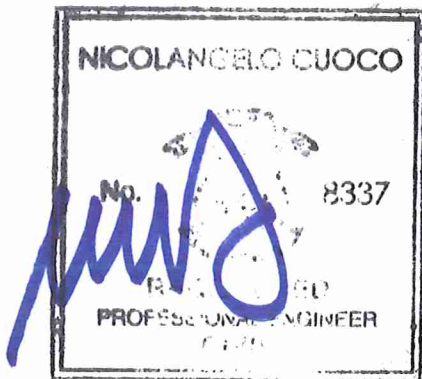

Coastline Consulting & Development
5-B Old Post Road, Madison CT 06443
(203) 245-8138

FIGURE 9 OF 10
ENGINEER DRAWING NOTES 1 OF 2

ACR REALTY, LLC
RHODE ISLAND RECYCLED METALS
434 & 444 ALLENS AVENUE
PROVIDENCE, RHODE ISLAND

DECEMBER 8, 2009

FILE NO.: 09-059

ENGINEERING DETAIL NOTES CONTINUED

STRUCTURAL STEEL:

1. THE DESIGN COMPLIES WITH THE AISC, "MANUAL OF STEEL CONSTRUCTION - ALLOWABLE STRESS DESIGN", NINTH EDITION.
2. STEEL WORK SHALL BE IN ACCORDANCE WITH AISC "SPECIFICATION FOR THE DESIGN, FABRICATION, AND ERECTION OF STRUCTURAL STEEL FOR BUILDINGS."
3. WELDING SHALL CONFORM TO THE 'STRUCTURAL WELDING CODE - STEEL', AS ADOPTED BY THE AMERICAN WELDING SOCIETY (AWS D1.1). A WELDER CERTIFIED IN ACCORDANCE WITH AWS STANDARDS SHALL PERFORM WELDING.
4. WELDING ELECTRODES SHALL BE E70XX-X AND COMPLY WITH AWS A5.1 AND AWS A5.5.
5. STRUCTURAL STEEL WIDE-FLANGE SHAPES SHALL CONFORM TO ASTM A992 OR ASTM A572, GRADE 50. OTHER STRUCTURAL STEEL SHAPES AND MISCELLANEOUS STEEL SHALL CONFORM TO ASTM A36, UNLESS OTHERWISE NOTED. STEEL TUBES SHALL CONFORM TO ASTM A500, GRADE B. STEEL PIPES SHALL CONFORM TO ASTM A53, GRADE B OR ASTM A500, GRADE B. STEEL PLATES SHALL CONFORM TO ASTM A588 FY = 50 KSI.
6. STEEL SHEET PILE SHALL BE ARBED AZ19-700, ASTM A328 MATERIAL AND COATED WITH TWO COATS OF BAR-RUST 235 FOR A TOTAL DRY FILM THICKNESS OF 15 MILS. COATING SHALL BE APPLIED TO BOTH SIDE OF THE STEEL AND TO THE LIMITS AS SHOWN ON THE DRAWINGS.

STEEL HARDWARE PIPE: ASTM A53 GRADE B, SCHEDULE 40
ANCHOR BOLTS: ASTM F1554
CARRIAGE BOLTS: ASTM A307
HIGH STRENGTH
STRUCTURAL BOLTS: ASTM A325, W/ HEXAGONAL HEADS
NUTS: ASTM A563
WASHERS: ASTM F436

7. STEEL HARDWARE LISTED ABOVE SHALL BE HOT DIPPED GALVANIZED.
8. TIE ROD ASSEMBLIES CONSISTING OF TIE ROD, STEEL COUPLERS, AND NUTS, SHALL BE DYWIDAG THREADBAR REINFORCING SYSTEM AS MANUFACTURED BY DYWIDAG SYSTEMS INTERNATIONAL, USA, INC. THREADBAR SHALL BE GRADE-75 CONFORMING TO ASTM A615 (EXCEPT FOR MARKINGS). TIE ROD ASSEMBLIES SHALL BE HOT DIPPED GALVANIZED.

CAST-IN-PLACE CONCRETE:

1. CONCRETE WORK SHALL CONFORM TO THE REQUIREMENTS OF ACI-318-LATEST EDITION 'BUILDING CODE REQUIREMENTS FOR STRUCTURAL CONCRETE' AS ADOPTED BY THE AMERICAN CONCRETE INSTITUTE.
2. DETAILING, FABRICATION, AND ERECTION OF REINFORCING STEEL SHALL CONFORM TO THE REQUIREMENTS OF ACI-318 AND ACI-315-LATEST EDITION 'DETAILS AND DETAILING OF CONCRETE REINFORCEMENT'.
3. CONCRETE SHALL BE NORMAL WEIGHT WITH A MINIMUM COMPRESSIVE STRENGTH OF 4000 PSI AT 28 DAYS. PORTLAND CEMENT SHALL BE TYPE II. CONCRETE SHALL CONTAIN 4% TO 6% ENTRAINED AIR AND HAVE A MAXIMUM WATER TO CEMENT RATIO OF 0.45.
4. REINFORCING STEEL SHALL CONFORM TO THE REQUIREMENTS OF ASTM A615 GRADE 60.

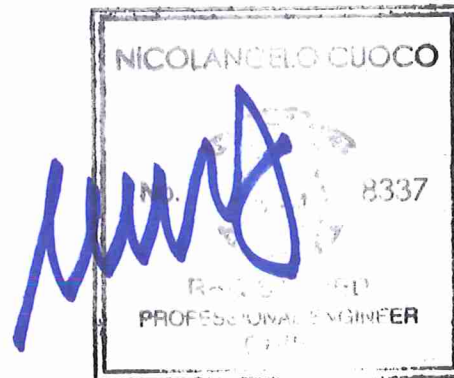

Coastline Consulting & Development
5-B Old Post Road, Madison CT 06443
(203) 245-8138

FIGURE 10 OF 10
ENGINEER DRAWING NOTES 2 OF 2

ACR REALTY, LLC
RHODE ISLAND RECYCLED METALS
434 & 444 ALLENS AVENUE
PROVIDENCE, RHODE ISLAND

DECEMBER 8, 2009

FILE NO.: 09-059